











MT 2020S

	20,20 m		18,20 m		7,80 m (200 kg) 10,10 m (80 kg)
	200 kg		1,40x0,70x1,10 m		90°+90°
	360°		DS Stabilizzatori a discesa in sagoma Stabilisateurs dans le gabarit Straight line stabilizers Stützen innerhalb der Fahrzeugbreite		3,5 t

MT2020S

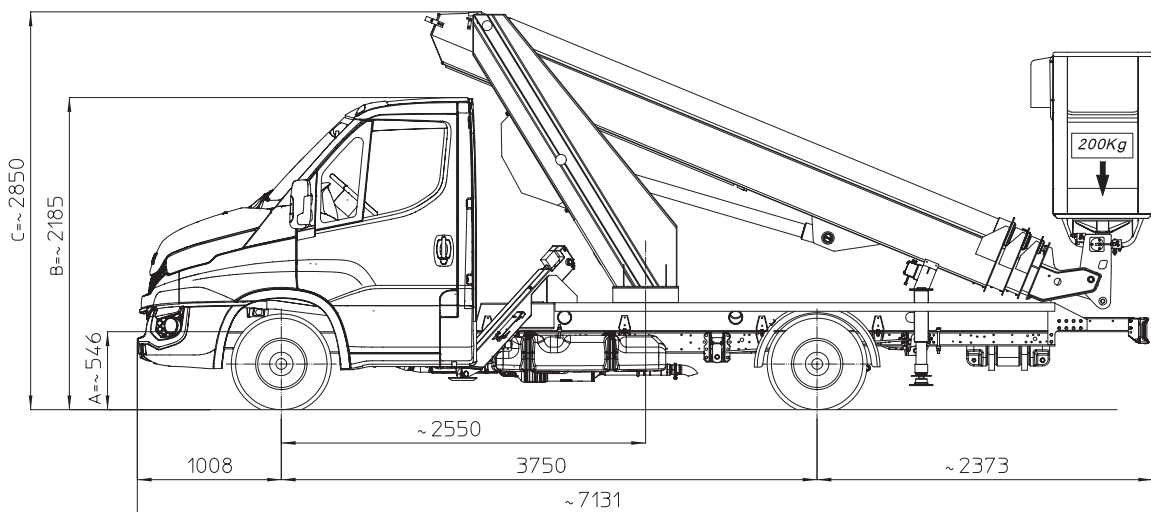
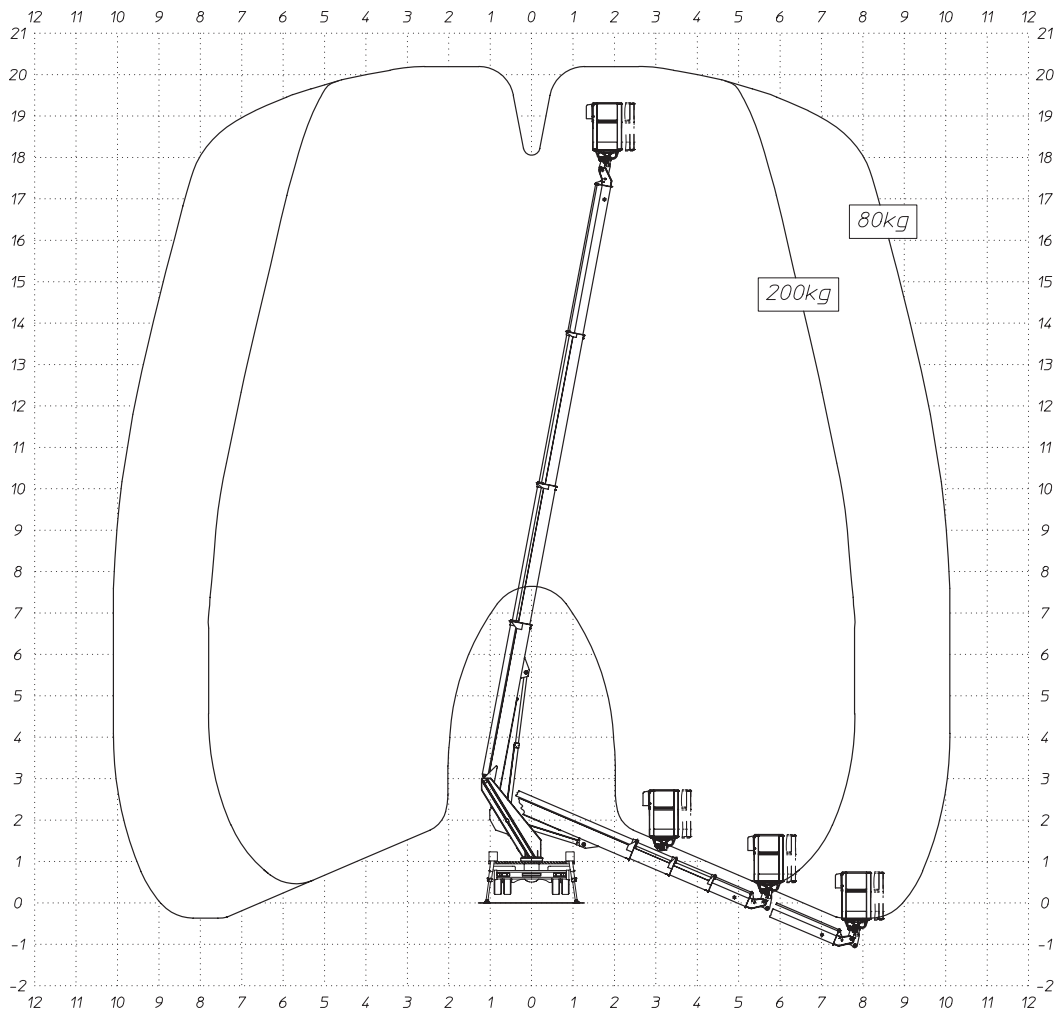

I R O N I K A

HYDROLIFT

Hydrolift Entretien-Reparation-Vente

Z.I. de la Bilonne, Lot N°4, 13170 Les Pennes, Mirabeau. Tél: 04 42 46 98 10 Fax: 04 42 46 98 14 www.hydrolift.fr